

***Hypertherm***<sup>®</sup>

## Echion™ waterjet pumps

Simplifying service

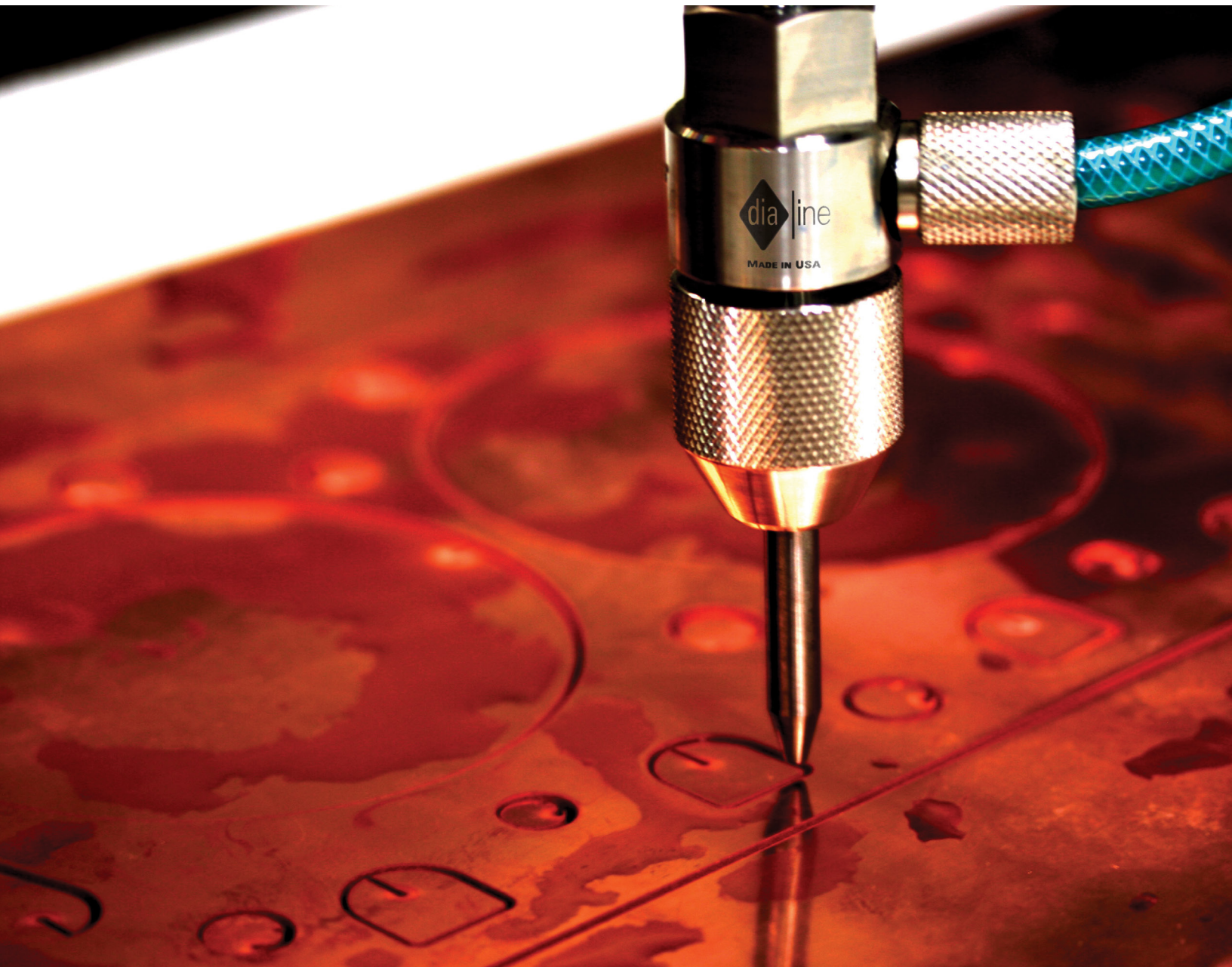



# New Echion™ pumps

Designed and built to simplify service

Echion pumps are the first waterjet pumps to incorporate cartridge seals that substantially reduce time to conduct maintenance. Equipped with standard features such as our next evolution of Advanced Intensifier Technology™ (AIT) and closed-loop proportional pressure control, our new pumps offer you consistent cut quality while ensuring trouble-free operation and reliability.

## Reduced maintenance time

Echion pumps include the next evolution of Hypertherm's Advanced Intensifier Technology. This technology eliminates soft, static high-pressure seals and incorporates industry-leading cartridge seal design, enabling rapid replacement of common consumables.

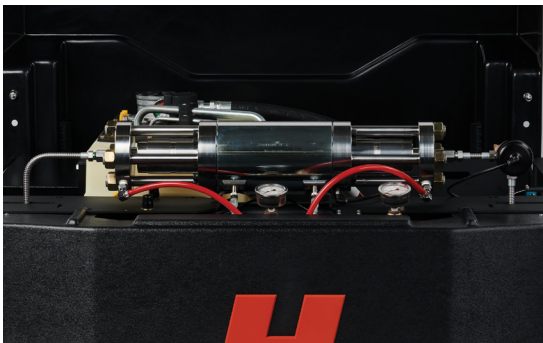

## Increased performance

Standard on all Echion pumps, closed-loop proportional pressure control adjusts for ambient pressure and temperature, oil viscosity and hydraulic system wear parts, to deliver consistent quality at optimum cutting speeds.

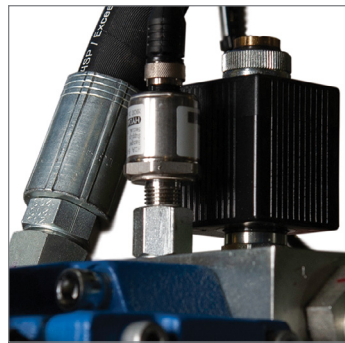

## Improved reliability and ease of service

With 20% fewer parts than earlier generations, new Echion pumps include user-friendly features such as common service components located front and center, quick-connect fittings, and an easy access bleed-down valve, to make maintenance faster, easier, and less expensive.

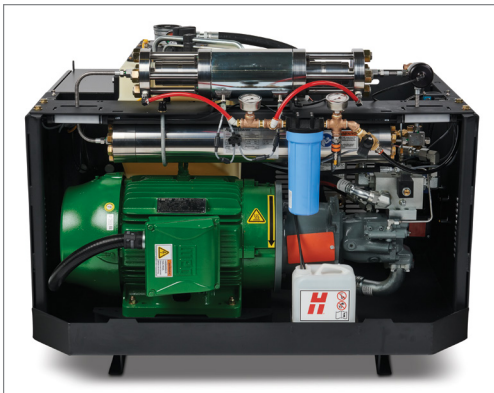

## Reduced footprint

Smart industrial design, including fully integrated cooling, allows a reduced footprint, enabling integration into small, tight spaces.

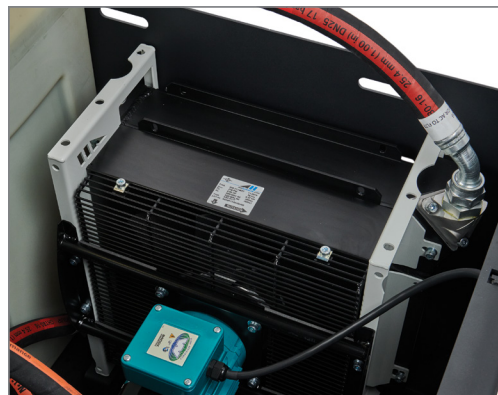

# The next evolution of Advanced Intensifier Technology simplifies system maintenance

Say goodbye to complicated seal repair. Hypertherm Echion™ pumps incorporate cartridge seals, enabling rapid replacement of common consumables, leading to quicker return to service. Add this to other key features of AIT and it's easy to see why Hypertherm is an unstoppable force in waterjet!

## Reversible cylinders

Enables error-proof maintenance

## Advanced piston design

Minimizes seal wear and improves component life

## Hard static seal

Reduces maintenance cost through elimination of soft seal components and no specialized tools

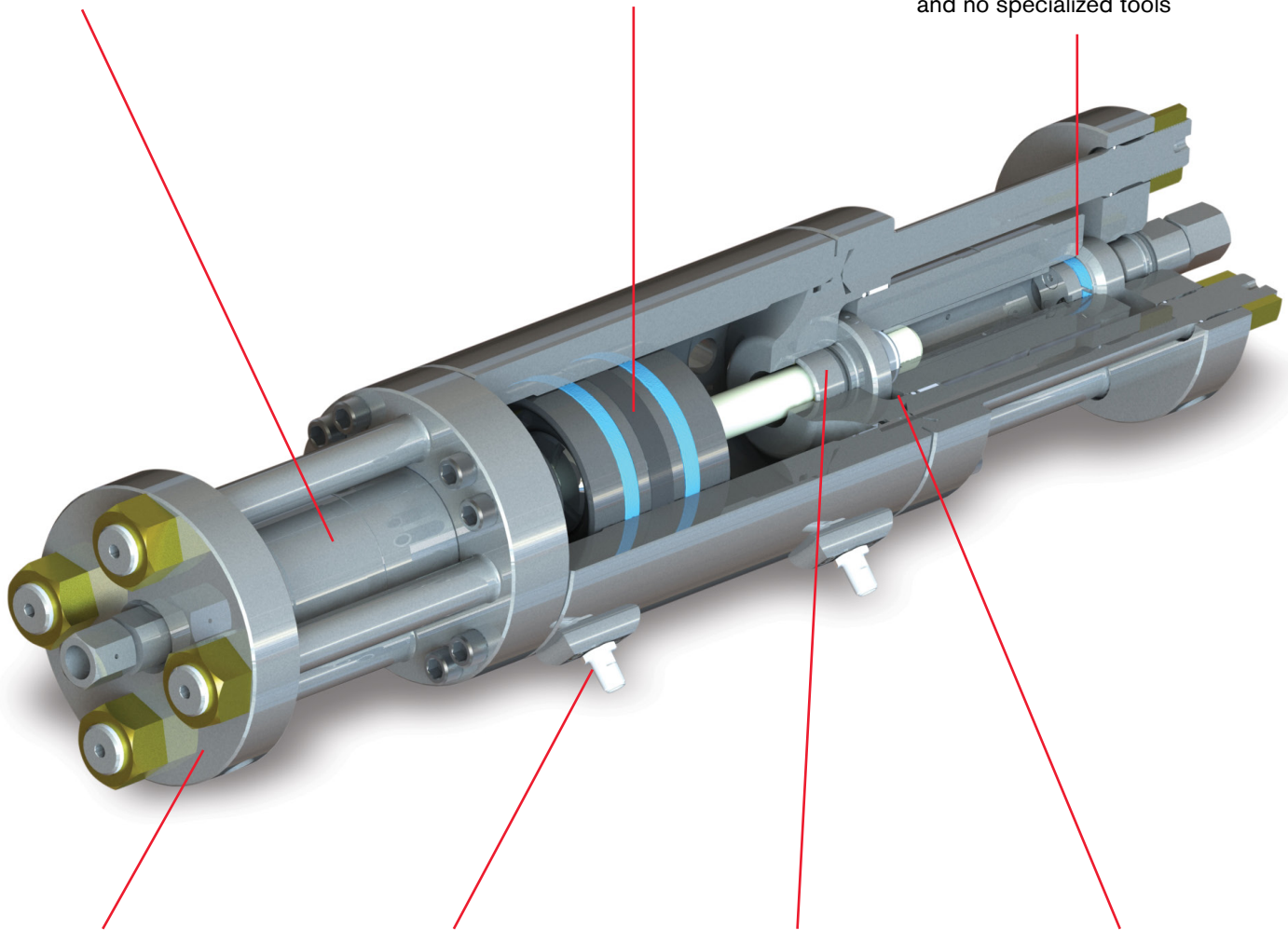

## Simple high-pressure ends

Enables easy access for maintenance

## Direct sense piston

Improves reliability and enables rapid stroke reversal to optimize system operation

## Oil and water seal access

Simplifies maintenance by locating seal access external to the center section

## Fluid routing

Collects fluid leaks to help keep your floor clean

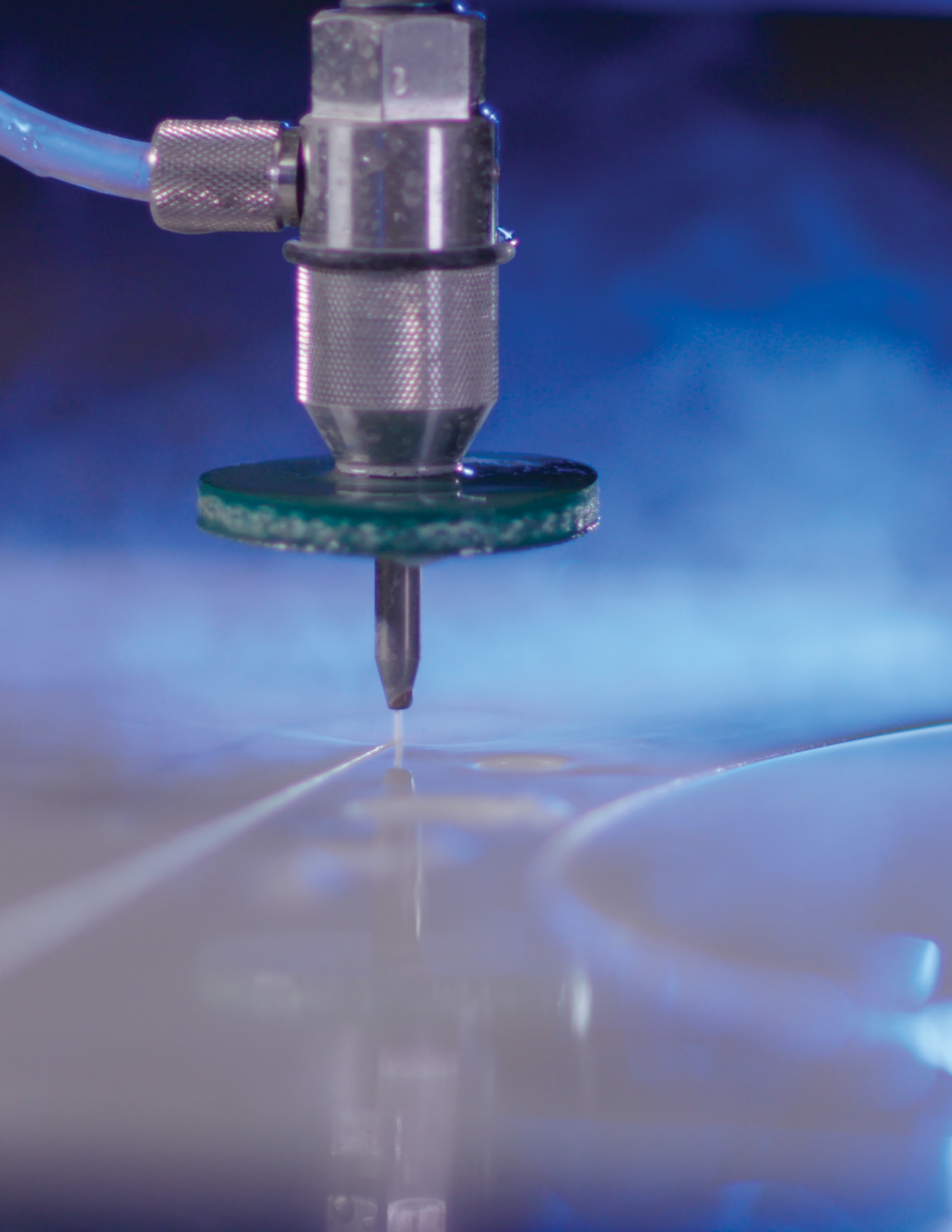

# Choosing the right Echion™ pump for your application

## System specifications



		Echion 15			Echion 30			Echion 50					
		50 Hz	60 Hz		50 Hz	60 Hz		50 Hz	60 Hz				
<b>GENERAL</b>	Maximum output	1.1 lpm (0.3 gpm)			2.3 lpm (0.6 gpm)			3.8 lpm (1.0 gpm)					
	Maximum orifice	0.18 mm (0.007")			0.28 mm (0.011")			0.35 mm (0.014")					
	Output pressure	Adjustable to 4,100 bar (60,000 psi)											
	Pressure control	Closed loop proportional pressure control – standard equipment											
	Bleed down valve	Air-actuated											
<b>PUMP POWER</b>	Motor power	11.2 kW (15 HP)			22.4 kW (30 HP)			37.3 kW (50 HP)					
	Voltage	400 V	208–230 V		460 V	400 V	208–230 V		460 V	400 V	208–230 V		460 V
	Full load	23 A	45–41 A		21 A	44 A	82–76 A		38 A	74 A	136–124 A		62 A
	Main breaker	30 A	60 A		30 A	60 A	100 A		60 A	100 A	200 A		100 A
	Motor starter (options if more than 1 listed)	Across-the-line			Wye-Delta Soft Start	Across-the-line	Across-the-line Soft Start	Wye-Delta Soft Start	Wye-Delta	Wye-Delta Soft Start			
<b>SPECIAL FEATURES</b>	Advanced Intensifier Technology	Included as standard equipment											
	Closed loop proportional pressure control	Included as standard equipment											
<b>PHYSICAL</b>	Width	1,090 mm (43")											
	Length	1,350 mm (53")											
	Height	1,010 mm (40")											
	Operating weight	775 kg (1,700 lbs.)			825 kg (1,850 lbs.)			925 kg (2,050 lbs.)					
<b>ACCESSORIES</b>	Boost pump	Optional											
	Integrated air over oil cooling	Optional											
	Bulkhead connection kit	Optional											
	Metric conversion kit	Optional											
	Pump mounted whip kit	Optional											





**STEP 100 OPERATION**

	<b>DANGER</b>
	Always wear eye protection when using this tool. Do not use this tool on any surface that is not designed for this purpose. Do not use this tool on any surface that is not designed for this purpose.
	<b>DANGER</b>
	Do not use this tool on any surface that is not designed for this purpose. Do not use this tool on any surface that is not designed for this purpose.
	<b>DANGER</b>
	Do not use this tool on any surface that is not designed for this purpose. Do not use this tool on any surface that is not designed for this purpose.
	<b>WARNING</b>
	Do not use this tool on any surface that is not designed for this purpose. Do not use this tool on any surface that is not designed for this purpose.



# A team to keep you up and running

Like you, we know that uptime is money. That's why we've put together an exceptional support team and all the information tools you need to stay ahead of unexpected problems and delays. It's all part of our commitment to service.

- Voicemail-free, expert waterjet support during business hours
- Global distribution ensures fast response and speedy parts delivery
- Hypertherm Waterjet Assistant mobile application for iOS and Android
- Online technical guides with step-by-step repair instructions (<http://assist.hypertherm.com>)
- Available on-site product training



Waterjet Assistant gives you instant access to detailed, step-by-step maintenance and repair procedures, including part numbers.

## Get the mobile app

Download the Hypertherm Waterjet Assistant mobile app from the App Store for iOS or from Google Play for Android using the links below.



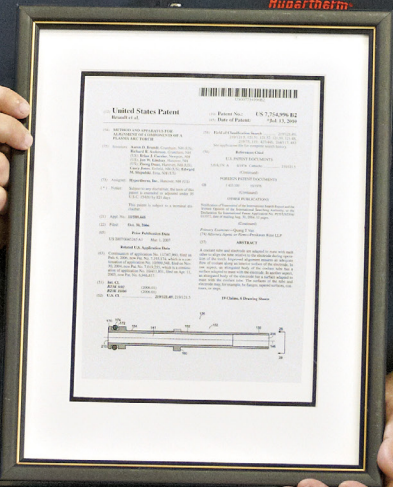

# 50 years of Shaping Possibility

With the right tools and a relentless focus on innovation, partnership, and community, we believe anything is possible.

Fifty years ago, in a small two car garage, Hypertherm® began our journey with simple, powerful ideas about business and an invention that shaped the future of industrial cutting. The same ideals that fueled our inception all those years ago are still what drive us today: A passion for challenging what is achievable with the products we create, the culture we foster, and the experience we deliver to our customers. As we look to the horizon and the next 50 years, we are proud that our people, partners, and innovations will shape the future with solutions that make anything possible for industries around the world.

At Hypertherm, we give shape to our customers' vision with the world's leading industrial cutting solutions. Every day we help individuals and companies around the world envision better, smarter and more efficient ways to produce the products that shape our world. So whether you're cutting precision parts in North America, constructing a pipeline in Norway, fabricating agricultural machinery in Brazil, cutting stone in Italy, gouging out welds in the mines of South Africa, or building a skyscraper in China, you can count on Hypertherm to help you not just cut parts but achieve your vision.

## 100% employee ownership matters

At Hypertherm, we are not just employees: we are all owners. Ownership is a powerful motivator that ensures our customers are our top priority. As owners, we make sure every product is built to the highest quality and that our service is second to none. And we build long-term relationships that deliver value for us, our partners and our customers.

## Worldwide presence and strength

Hypertherm is a key partner for your fabrication needs and has built a global organization focused on providing high-performance cutting solutions.

## Key elements of the Hypertherm formula include:

- Dedicated Associates focused on customer-centered product design and support
- Local sales and service
- Broad application experience and proven results
- Sustainable and ethical business practices benefit our customers and communities

**HELPING YOU  
SHAPE THE WORLD.**



PLASMA | LASER | WATERJET | AUTOMATION | SOFTWARE | CONSUMABLES

To learn more, visit [www.hypertherm.com/waterjet](http://www.hypertherm.com/waterjet)

Hypertherm, Echion, Advanced Intensifier Technology, and Shaping Possibility are trademarks of Hypertherm, Inc. and may be registered in the United States and/or other countries.

Environmental stewardship is one of Hypertherm's core values, and it is critical to our success and our customers' success. We are striving to reduce the environmental impact of everything we do. For more information: [www.hypertherm.com/environment](http://www.hypertherm.com/environment).

© 4/2020 Hypertherm, Inc. Revision 0

897920



**Hypertherm**<sup>®</sup>  
SHAPING POSSIBILITY<sup>®</sup>

